

REV	DESCRIPTION	DSG	APR	DATE

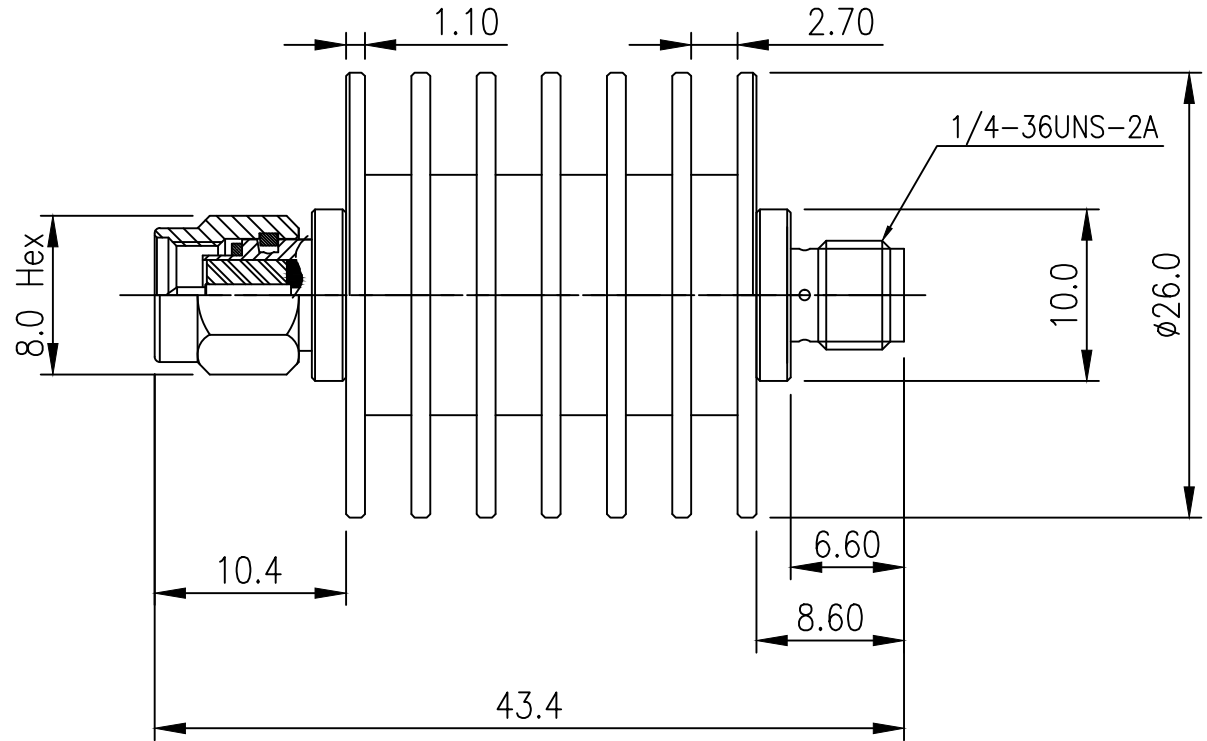

1. Electrical Spec.

- 1.1 Impedance : 50 ohm
- 1.2 Frequency range : DC ~ 8GHz
- 1.3 Nominal Attenuation : 40 dB
- 1.4 Attenuation Accuracy : ± 0.5 dB
- 1.5 VSWR : 1.2:1
- 1.6 Input Power, CW : 10 Watts
- 1.7 Peak Power: 1KW

2. Mechanical

- 2.1 Center contact retention force : 6 lb Min.
- 2.2 Center contact proof torque : 4 in.oz. Min.
- 2.3 Coupling nut torque of 12in-lb(min)

3. Environmental Spec.

- 3.1 Temperature range : -55°C to 125°C
- 3.2 2011/65/EU (RoHS) : Compliant

UNLESS OTHERWISE SPECIFIED : ALL DIMS IN MILLIMETERS TOLERANCES ON DECIMALS 1 PLACE ± 0.20 ANGLE $\pm 1.0^{\circ}$ 1.6g 2 PLACE ± 0.10 REMOVE BURRS. BREAK SHARP EDGES		THIRD ANGLE	RFCM	
DRAW	DESIGN	CHECK		
<i>MX HONG</i>		<i>X</i>		8GHz SMA(M-F) 40dB 10W Fixed Attenuator
2019.10.04				
Material	-			SIZE A4
Finish	SEE NOTE 1.			DWG NO. A1
				REV A
				Scale : NS Do Not Scale Drawing 1 of 1